

... from development to
implementation



Czech manufacturer of testing machines and automation



Electrodynamic testing
machines series
EP.4 up to $\pm 10\,000\text{ N}$ – 150 Hz



Production of material testing machines and automation

Key features and parts of EP.4

Stiffness, precision and high dynamics with fully digital control...

The EP series electrodynamic testing machines based on linear motor technology are designed for testing a wide range of materials and components in dynamic and static modes. EP machines are used in industries where oil-free and noiseless drive technology is preferred for axial dynamic loads of $\pm 10\,000\text{N}$, such as the plastics, aerospace or medical industries. What can be tested on the machines? Composites, metals, plastics, dental, knee or joint implants, etc.



The robust vertical stand design with an adjustable crosshead has high rigidity, mechanical resistance and durability, guaranteeing 100% repeatability of results with small installations. The adjustment of the cross head can be ensured mechanically or fully electrically, including process monitoring. The integrated T-slot plate with special suspension at the base absorbs up to 95% of machine vibrations.



Specially designed compact oil-free linear actuator developed by LABORTECH with high dynamics, low moment of inertia at a stroke of 70 mm, low noise level at maximum power and maximum test frequency up to **150 Hz** at full load. Cooling is provided by controlled air circulation. Power supply for the whole machine - single-phase 230V / 32A.



The machine is controlled by the new measuring and control electronics of the EDCi series with a sampling frequency of 10 kHz. Resolution level of analog signals $\pm 250,000$ points (20 ms). PC connection - Ethernet 10/100 Mbit, USB 2.0. Control and diagnostics of the machine using the RMCi remote control with LCD display. Force sensor with integrated acceleration sensor and digital optical extension sensor with the possibility of expansion by a combined axial / torsion sensor.



Intelligent, intuitive and powerful DYNPACK software designed for static and dynamic applications. It will help you increase the productivity and quality of testing in your test rooms and testing laboratories by using different modules for each test standard.



Great versatility of the EP.4 series combined with the extension of the machine with various accessories: test grips and special jigs, temperature chambers and high-temperature furnaces, vessels and baths with saline, video extensometers, extension by torsion testing up to $\pm 25\text{Nm}$, integration of force sensor in the lower or the top of the machine, guide bar extensions and other accessories.



Based on the concept and construction, LABORTECH machines comply with all the above-mentioned EC directives on machinery and equipment. Only state-of-the-art safety techniques and proven industrial components are used that work in accordance with the new safety functions according to ENB ISO 13850-SIL 1 / PL. Safe setting mode according to EN 60204-1 via speed.



...from development to implementation



Production of material testing equipment and automation

Software DYNPACK

Intuitive long-term test software you'll love...

DYNPACK - intelligent, intuitive and powerful software that will help you increase productivity and quality of testing in your test rooms and testing laboratories. You can streamline, refine, and accelerate the performance of your tests and adapt your testing environment to make it easy for operators to measure the mechanical properties of tensile, flexural, and torsional materials with support for EN, ISO, DIN, ASTM, and GOST standards.

Features of software DYNPACK

- Unlimited number of test methods.
 - Modular system of libraries designed for standardized tests - to choose for activation.
 - Evaluation of optional parameters: maximum force, strength, elongation, tensile, stress, 5 different reference points, etc ..
 - Real-time graph, possibility of individual processing after the test
 - Bulk graphs, Zoom, serial testing
 - Data export to ASCII, EXCEL, WORD, Eclipse, Diadem, Q- DAS,
 - Clamping length setting for each method
 - Display of multiple quantities on the x, y axes
-
- Online display of up to 6 graphs with arbitrary quantities in the x, y axis
 - Control of feed rate depending on elongation, force, stress, elongation, etc ..
 - Software control of hydraulic and pneumatic jaws, temperature, automatic extensometer
 - Receiving sample dimensions from peripheral devices
 - Data collection from analog and digital external meters
 - Setting user rights, operator login
 - Custom setting of test results - Automatic saving of results according to the selected tree, database
 - Statistical evaluation - 12 language mutations (Cs, En, De, Fr, Pl, It, Es, Ru, NI, Tr, Zh, Pt

Module - Axial torsion test, commands from a file, long-term data storage, etc.

- Module for leading of 2 control electronics of the EDCi series, free programming system
- Commands: position, sinus, triangle, rectangle, stop, remain, offset, amplitude, frequency
- Option to save the N-cycle, any number of steps, calculation, zeroing in different positions
- Issuing sinusoidal commands with half amplitude
- Starting the test in different directions – eg. the Y axis is in tension / pressure
- Creation of parallel storage, including maintenance for storing all data from all channels

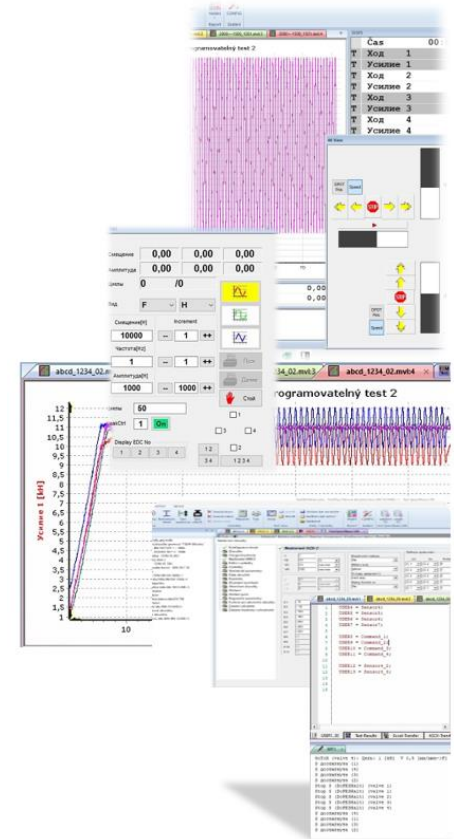
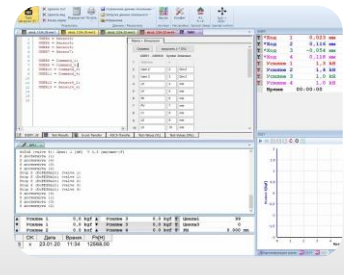
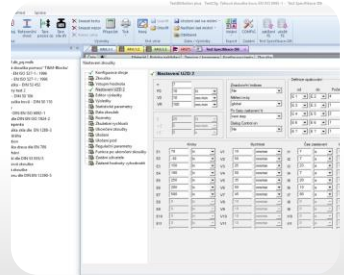
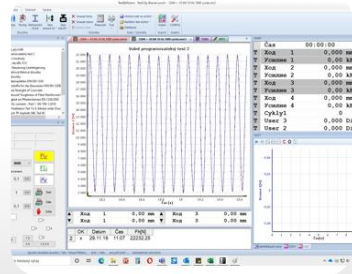

Choose your own machine accessories!

You can test everything with our wide range of accessories...

A wide range of various accessories, including software, will allow you to configure the machine exactly according to your ideas, technical requirements and standards. All you have to do is fill in the simple form [HERE](#) and we will send you a price offer immediately. We offer both standard accessories and "tailor-made" accessories.



Production of material testing machines and automation

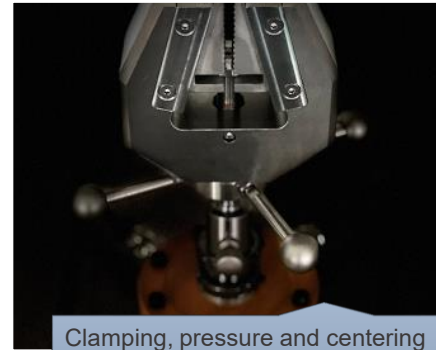

Clamping, pressure and centering fixtures. Selection according to nominal force, surface, test frequency, standard, etc.



Extensometers - contactless, with limited information or full deformation.



High temperature furnaces up to 1600 ° C.



Temperature chambers with a range from - 196 ° C to + 350 ° C integrated in the EP series 1 machine

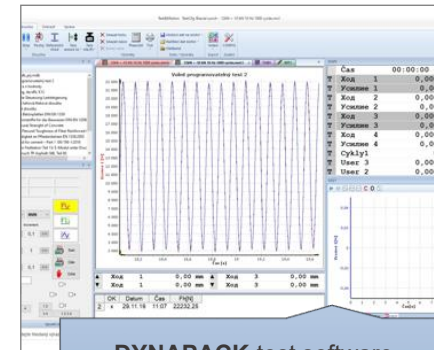

DYNAPACK test software supplied by LABORTECH with various test modules.



Production of material testing machines and automation

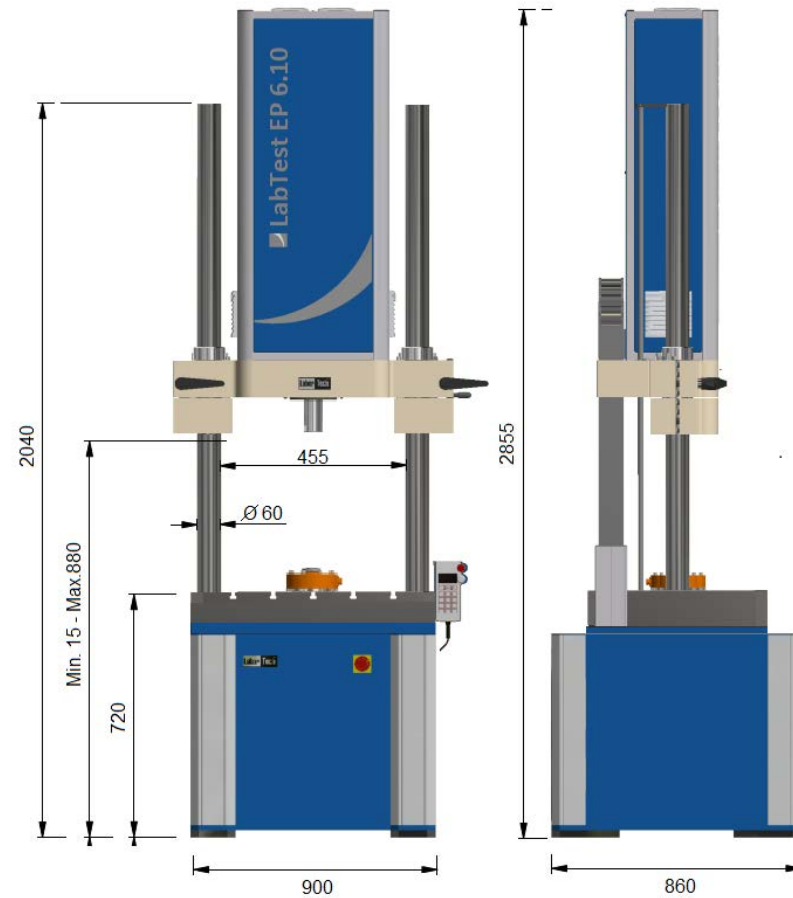

Additional accessories

- 1.17990121 - EP machine extension - +410 mm or according to the customer's wishes
- 2.0101xx17 – Force transducers with a higher accuracy class
- 2.04xxxx21 - Axial, torsional grips, compression plates, 3 and 4 point bends, etc.
- 2.06xxxx17 – Temperature chambers
- 2.02xxxx17 – basic 3 types of connection + connection according to the customer's wishes
- Protective safety covers with electrical protection - ITEM or AXELENT

LabTest EP.4 series – stand design

Technical data	Units	EP 6.030.00
Product code		1.17300123
Max. dynamic load	N	± 10 000
Max. continuous static load	N	± 7 000
Torsional dynamic moment	Nm	± 100
Torsional static moment	Nm	± 100
Torsion angle ¹	°	± 160°
Piston stroke	mm	70
Positioning accuracy and repeatability	um	± 1,5
Max. test frequency ²	Hz	150
Max. test speed	m/s	1,5
Number of columns		2
Adjustment of the crosshead		Electro
Clamping the crossbar		Manual
T groove plate - size / spacing of grooves	mm	10 / 100
Stiffness of the machine at a height of 500 mm	kN/mm	440
Machine weight	kg	935
Environmental conditions		
Working environment temperature	°C	+10 ... +35
Storage temperature	°C	-25 ... +55
Humidity of the working environment	%	<90
Electrical connection		
Supply voltage / frequency	V/Hz	230V/50-60
Number of phases		1
Machine cooling		
Power of remove air	kW	0.726
Max. amount of exhaust air	m ³ /hod	98
Color combination	RAL	1015, 5015

¹ Variants with angle of rotation ± 16 or 135 ° ² Axial frequency
 Technical changes reserved during development, machine parameters at room temperature.